	Title:	Performance report for SiT5156, 10 MHz, Clipped Sinewave		
	Type:	Performance report	Rev:	1.2
	Orig:		Date:	July 17, 2018

Performance report for SiT5156 - 10 MHz, Clipped Sinewave

Data:

- Frequency stability over temperature
- Frequency slope
- Frequency hysteresis over temperature
- Allan Deviation
- MTIE
- TDEV
- Phase noise
- Output frequency power supply sensitivity
- Output frequency load sensitivity
- Output waveforms
- Pull range linearity
- Random Phase jitter, Duty cycle, Rise/Fall time, Amplitude, Current consumption

SiTime	Title:	Performance report for SiT5156, 10 MHz, Clipped Sinewave		
	Type:	Performance report	Rev:	1.2
	Orig:		Date:	July 17, 2018

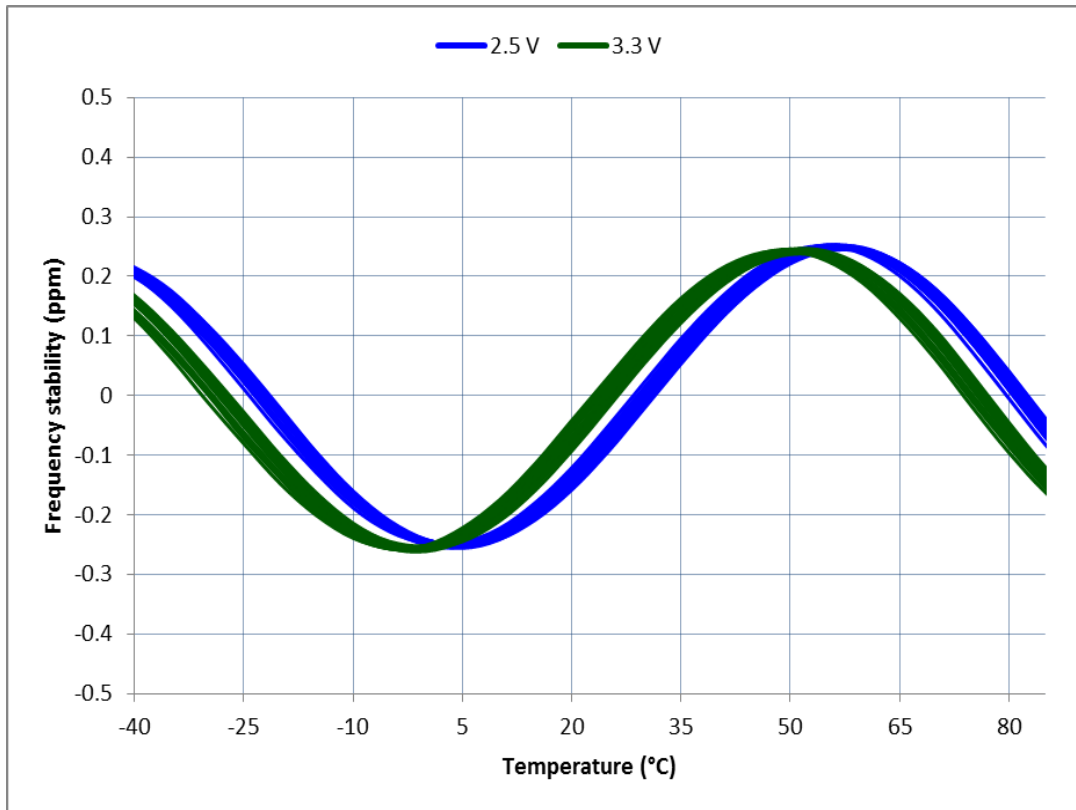

Figure 1: Frequency stability* over temperature, 2.5 V – 3.3 V, 30 devices

*SiT5156 frequency stability is independent of output frequency.

The information contained in this document is confidential and proprietary to SiTime Corporation. Unauthorized reproduction or distribution is prohibited.



Title:	Performance report for SiT5156, 10 MHz, Clipped Sinewave		
Type:	Performance report	Rev:	1.2
Orig:		Date:	July 17, 2018

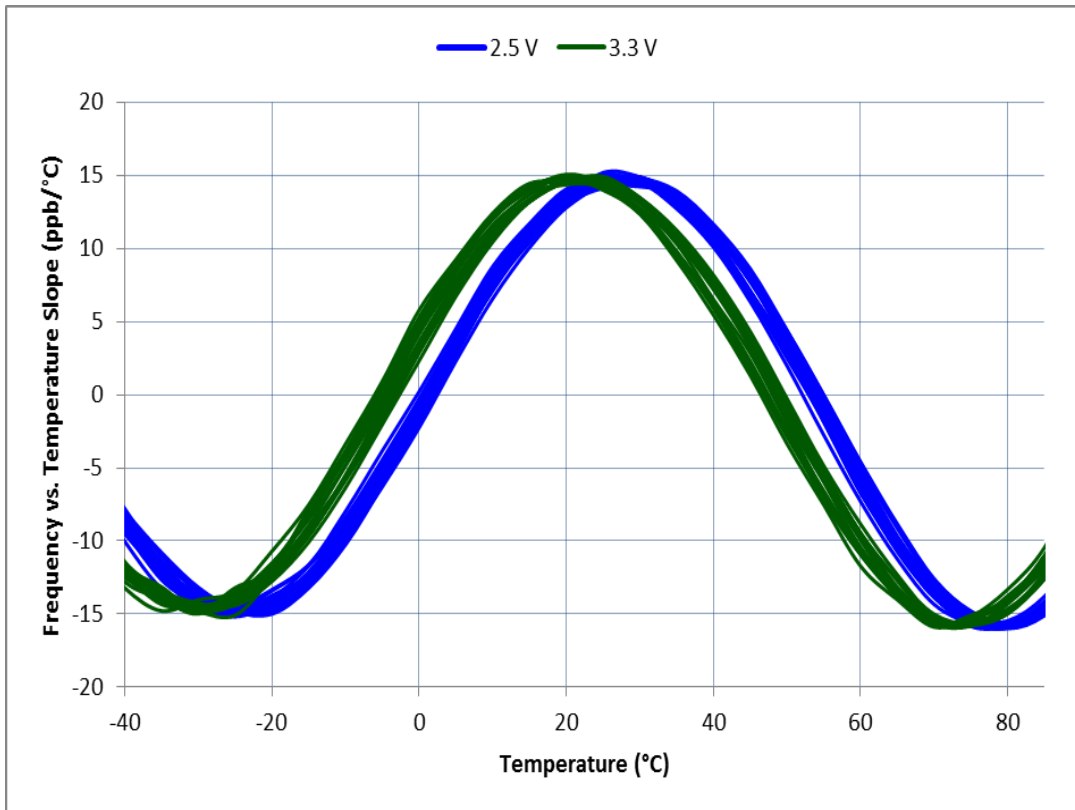

Figure 2: Frequency versus temperature slope, 30 devices

SiTime	Title:	Performance report for SiT5156, 10 MHz, Clipped Sinewave		
	Type:	Performance report	Rev:	1.2
	Orig:		Date:	July 17, 2018

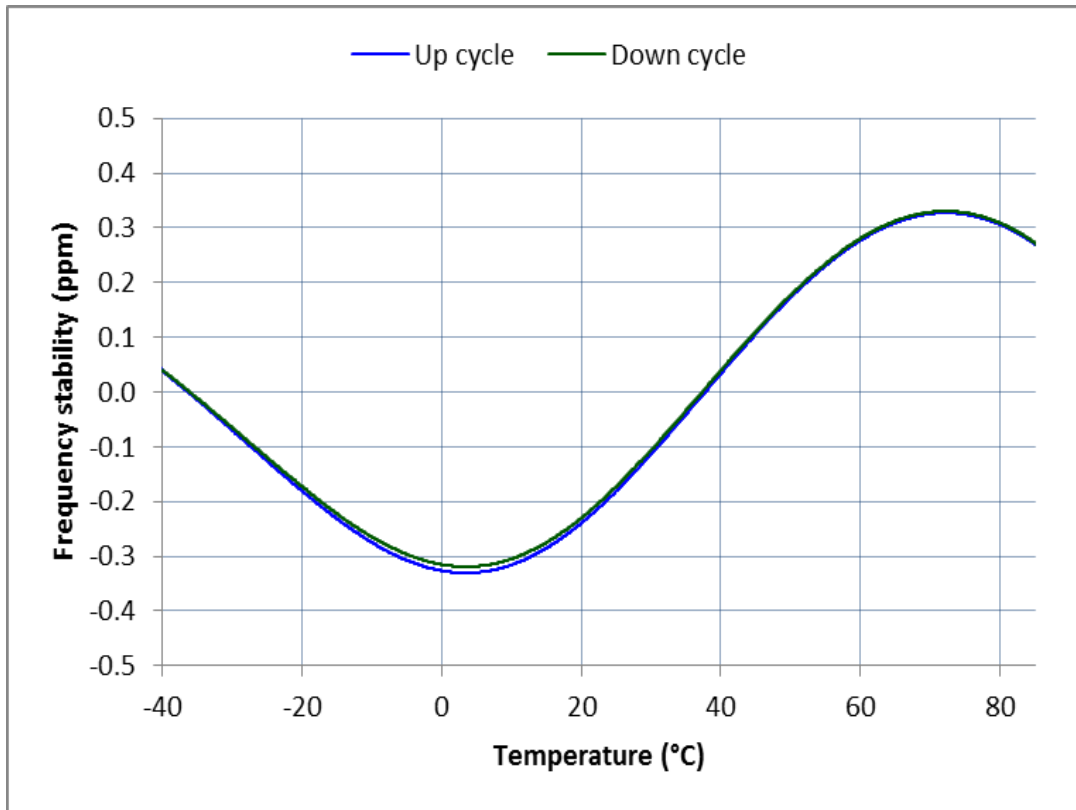

Figure 3: Frequency hysteresis over temperature, temperature ramp rate 0.5°C/min

The information contained in this document is confidential and proprietary to SiTime Corporation. Unauthorized reproduction or distribution is prohibited.

SiTime	Title:	Performance report for SiT5156, 10 MHz, Clipped Sinewave		
	Type:	Performance report	Rev:	1.2
	Orig:		Date:	July 17, 2018

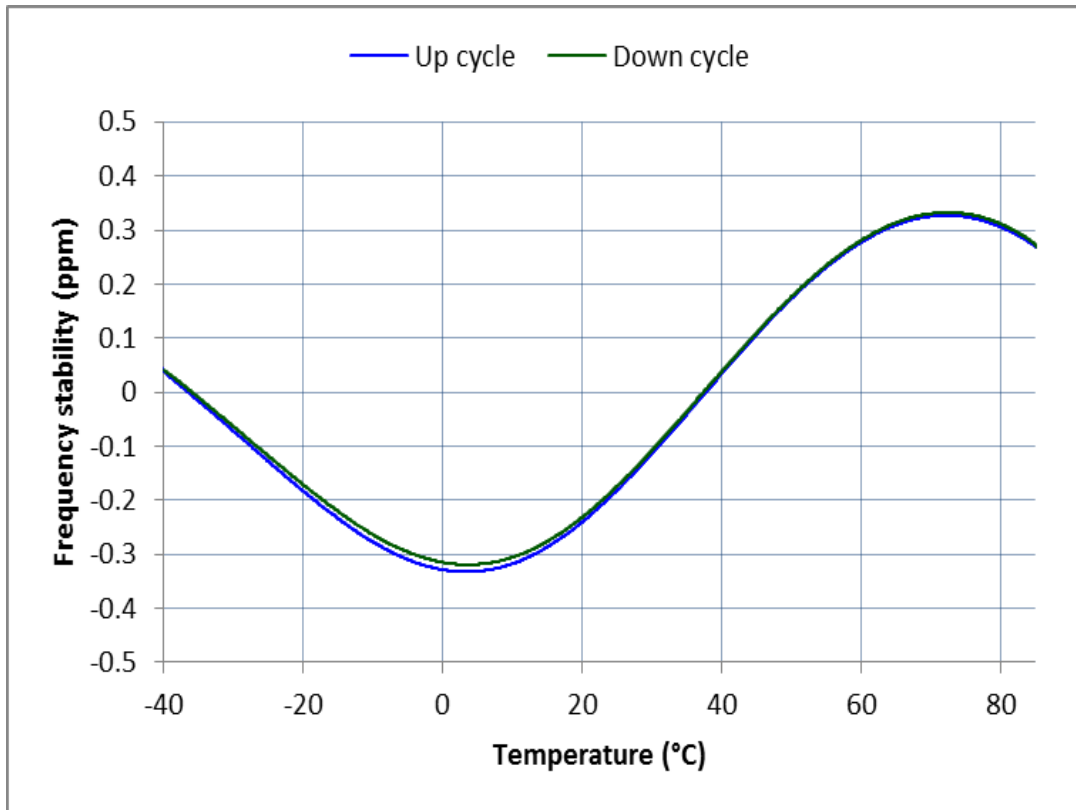

Figure 4: Frequency hysteresis over temperature, temperature ramp rate 1°C/min

The information contained in this document is confidential and proprietary to SiTime Corporation. Unauthorized reproduction or distribution is prohibited.

SiTime	Title:	Performance report for SiT5156, 10 MHz, Clipped Sinewave		
	Type:	Performance report	Rev:	1.2
	Orig:		Date:	July 17, 2018

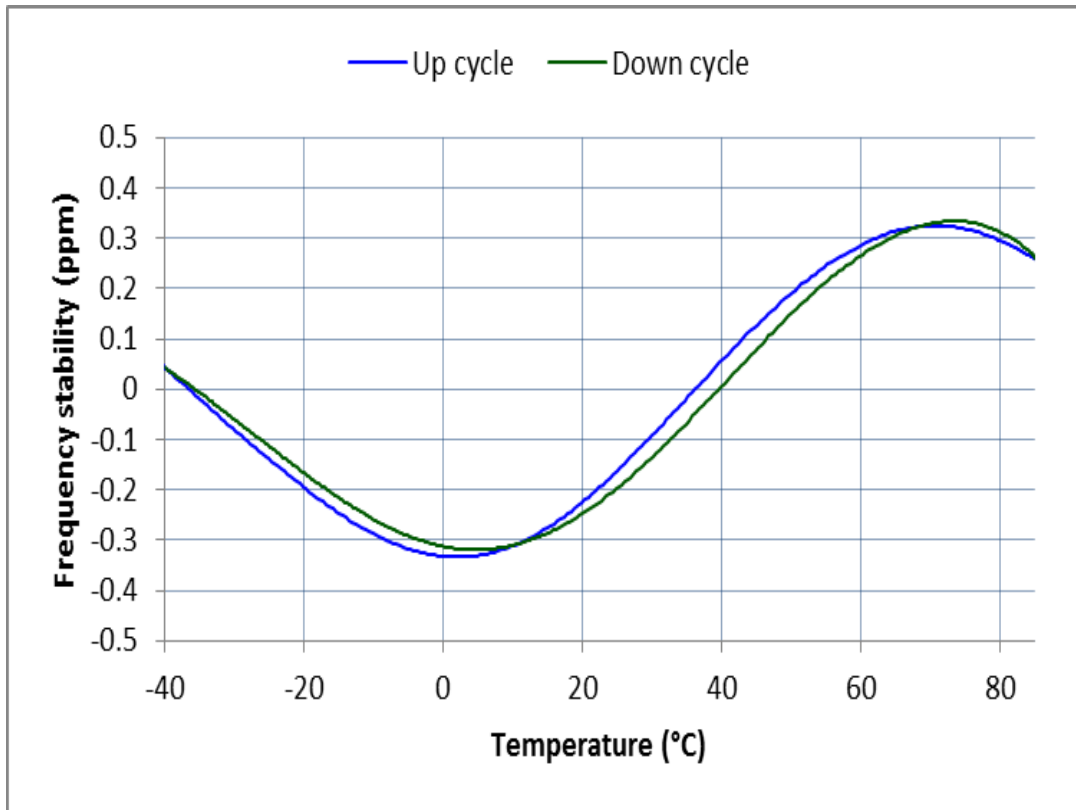

Figure 5: Frequency hysteresis over temperature, temperature ramp rate 8°C/min

The information contained in this document is confidential and proprietary to SiTime Corporation. Unauthorized reproduction or distribution is prohibited.

SiTime	Title:	Performance report for SiT5156, 10 MHz, Clipped Sinewave		
	Type:	Performance report	Rev:	1.2
	Orig:		Date:	July 17, 2018

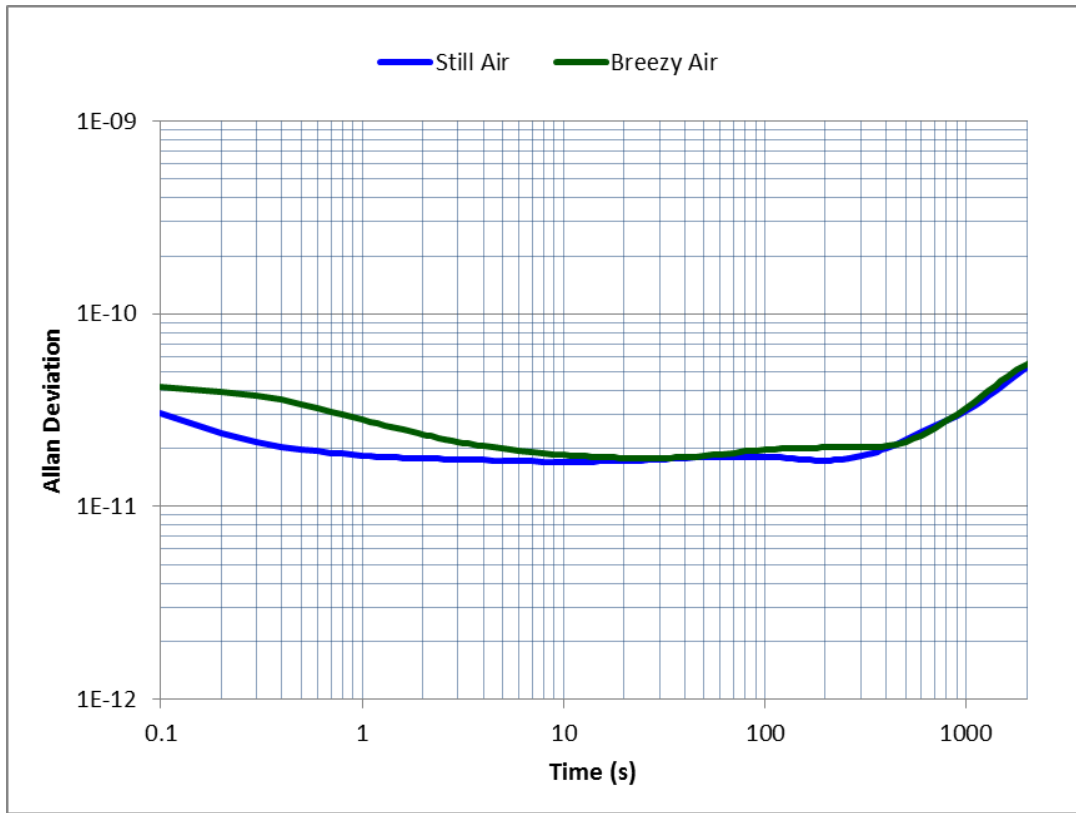

Figure 6: Allan deviation

Table 1: Allan deviation

Time (s)	0.1	1	10	100	1000
Still Air	3.04E-11	1.84E-11	1.71E-11	1.81E-11	3.16E-11
Breezy Air	4.17E-11	2.82E-11	1.85E-11	1.98E-11	3.26E-11



Title:	Performance report for SiT5156, 10 MHz, Clipped Sinewave		
Type:	Performance report	Rev:	1.2
Orig:		Date:	July 17, 2018

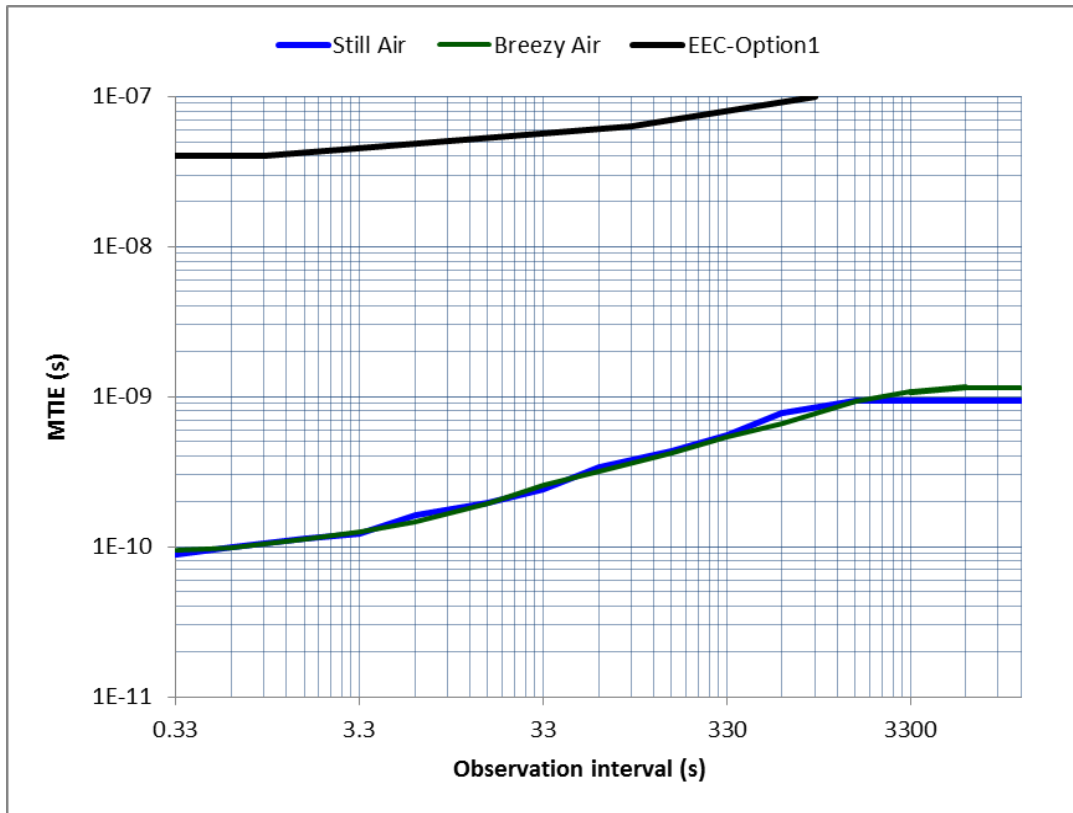

Figure 7: MTIE (PLL bandwidth = 3 Hz)



Title:	Performance report for SiT5156, 10 MHz, Clipped Sinewave		
Type:	Performance report	Rev:	1.2
Orig:		Date:	July 17, 2018

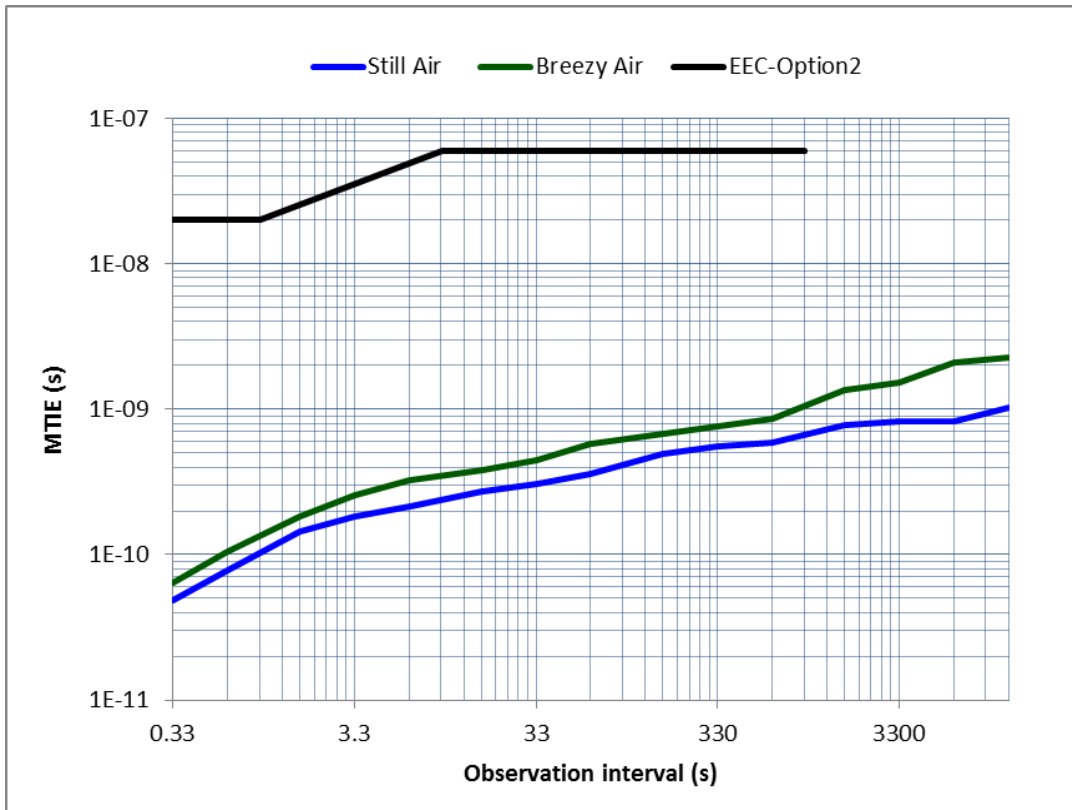

Figure 8: MTIE (PLL bandwidth = 0.1 Hz)



Title:	Performance report for SiT5156, 10 MHz, Clipped Sinewave		
Type:	Performance report	Rev:	1.2
Orig:		Date:	July 17, 2018

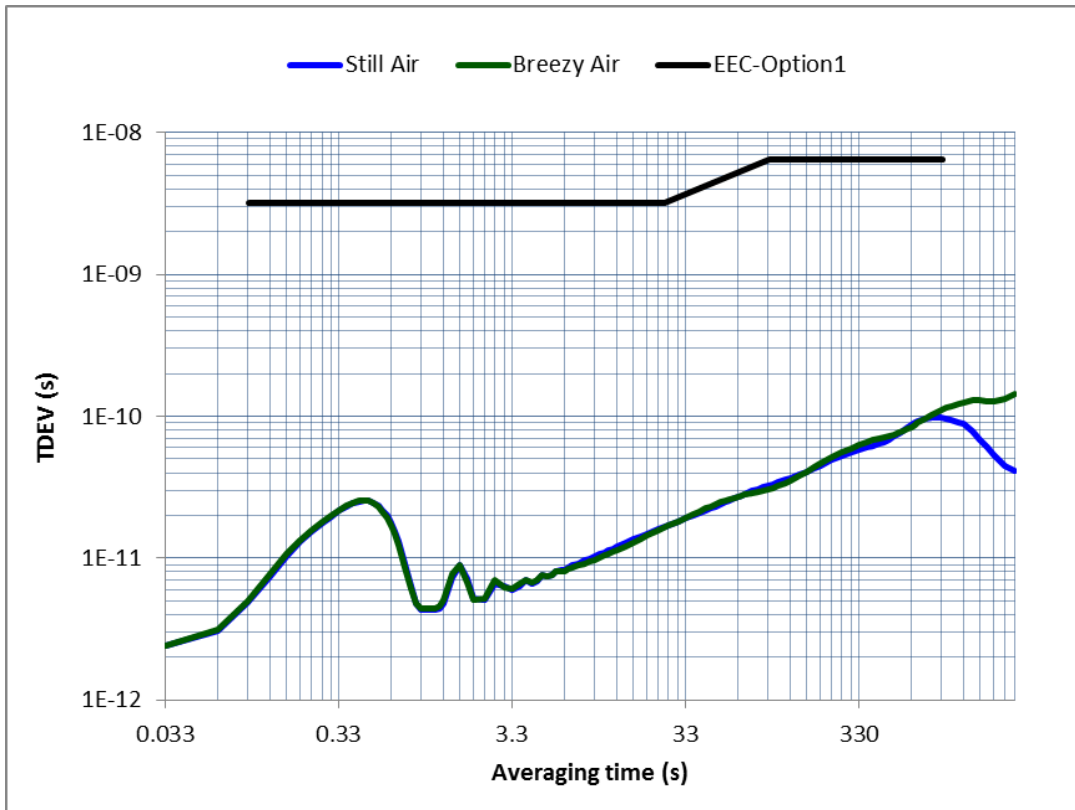

Figure 9: TDEV (PLL bandwidth = 3 Hz)

SiTime	Title:	Performance report for SiT5156, 10 MHz, Clipped Sinewave		
	Type:	Performance report	Rev:	1.2
	Orig:		Date:	July 17, 2018

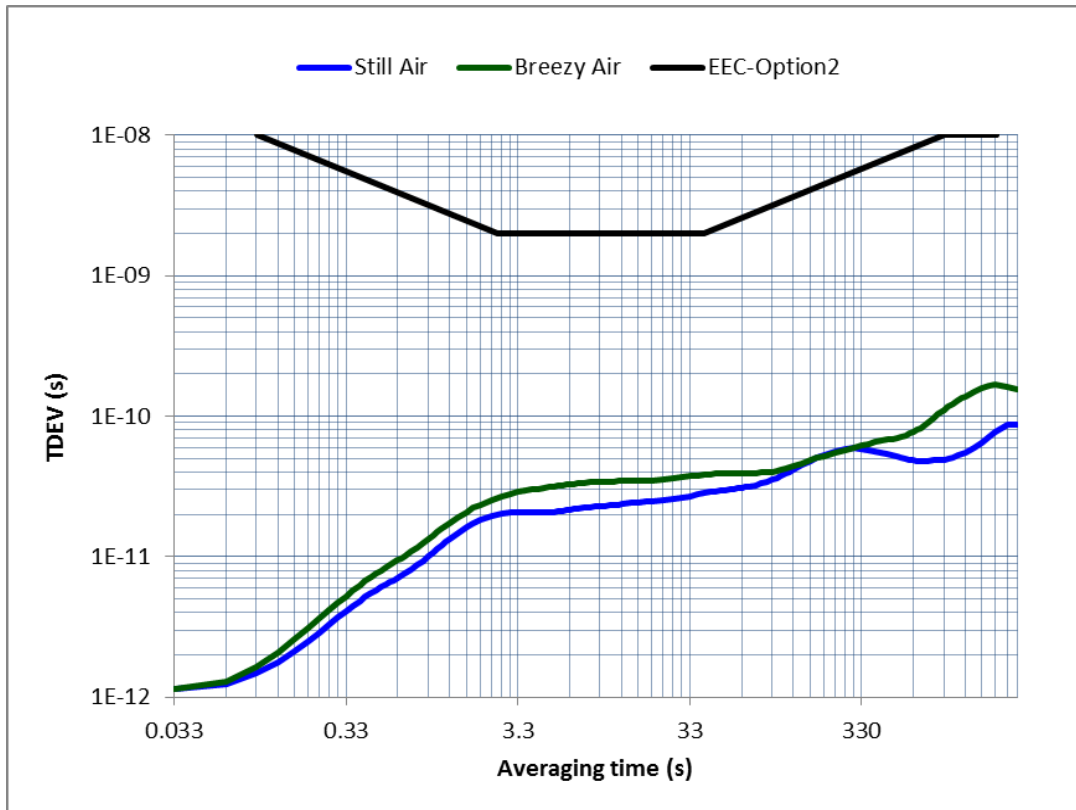

Figure 10: TDEV (PLL bandwidth = 0.1 Hz)

The information contained in this document is confidential and proprietary to SiTime Corporation. Unauthorized reproduction or distribution is prohibited.

SiTime	Title:	Performance report for SiT5156, 10 MHz, Clipped Sinewave		
	Type:	Performance report	Rev:	1.2
	Orig:		Date:	July 17, 2018

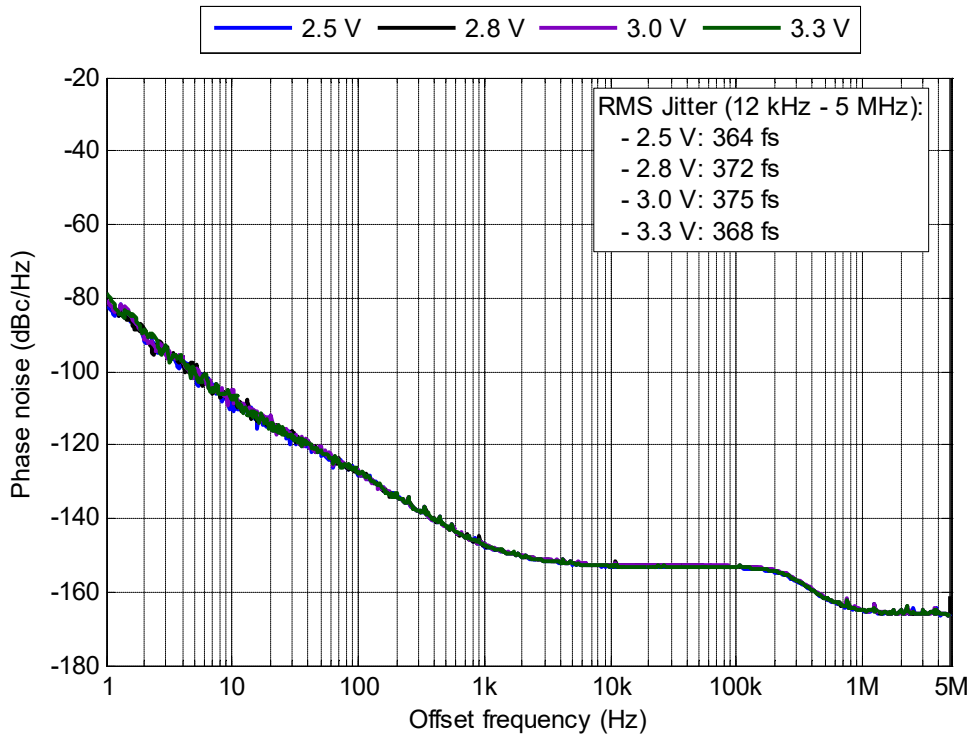

Figure 11: Phase noise TCXO/DCTCXO, 2.5 V - 3.3 V

Table 2: Phase noise TCXO/DCTCXO

Voltage	Phase noise (dBc/Hz)							
	1 Hz	10 Hz	100 Hz	1 KHz	10 KHz	100 KHz	1 MHz	5 MHz
2.5 V	-81.7	-108.9	-127.5	-147.1	-153.1	-153.4	-165.0	-166.3
2.8 V	-80.6	-106.7	-127.5	-147.1	-152.9	-153.2	-164.8	-161.3
3.0 V	-80.5	-105.2	-127.3	-147.2	-152.7	-153.1	-164.7	-166.1
3.3 V	-78.6	-106.5	-127.3	-147.1	-153.0	-153.3	-164.7	-166.1

SiTime	Title:	Performance report for SiT5156, 10 MHz, Clipped Sinewave		
	Type:	Performance report	Rev:	1.2
	Orig:		Date:	July 17, 2018

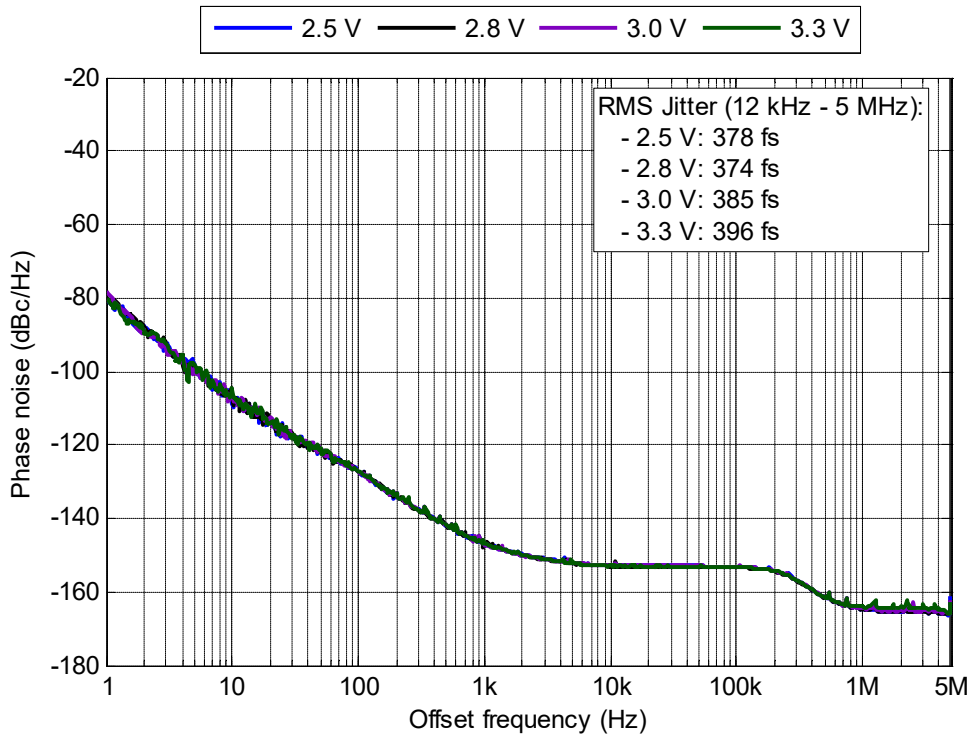

Figure 12: Phase noise VCTCXO, 2.5 V - 3.3 V

Table 3: Phase noise VCTCXO

Voltage	Phase noise (dBc/Hz)							
	1 Hz	10 Hz	100 Hz	1 KHz	10 KHz	100 KHz	1 MHz	5 MHz
2.5 V	-80.1	-108.7	-127.2	-146.7	-153.0	-153.2	-164.6	-161.2
2.8 V	-79.7	-106.2	-127.1	-147.2	-153.0	-153.4	-164.6	-162.2
3.0 V	-78.0	-105.7	-127.2	-146.7	-152.8	-153.2	-164.4	-162.1
3.3 V	-79.9	-104.6	-127.2	-146.7	-153.0	-153.3	-163.9	-162.6

The information contained in this document is confidential and proprietary to SiTime Corporation. Unauthorized reproduction or distribution is prohibited.

SiTime	Title:	Performance report for SiT5156, 10 MHz, Clipped Sinewave		
	Type:	Performance report	Rev:	1.2
	Orig:		Date:	July 17, 2018

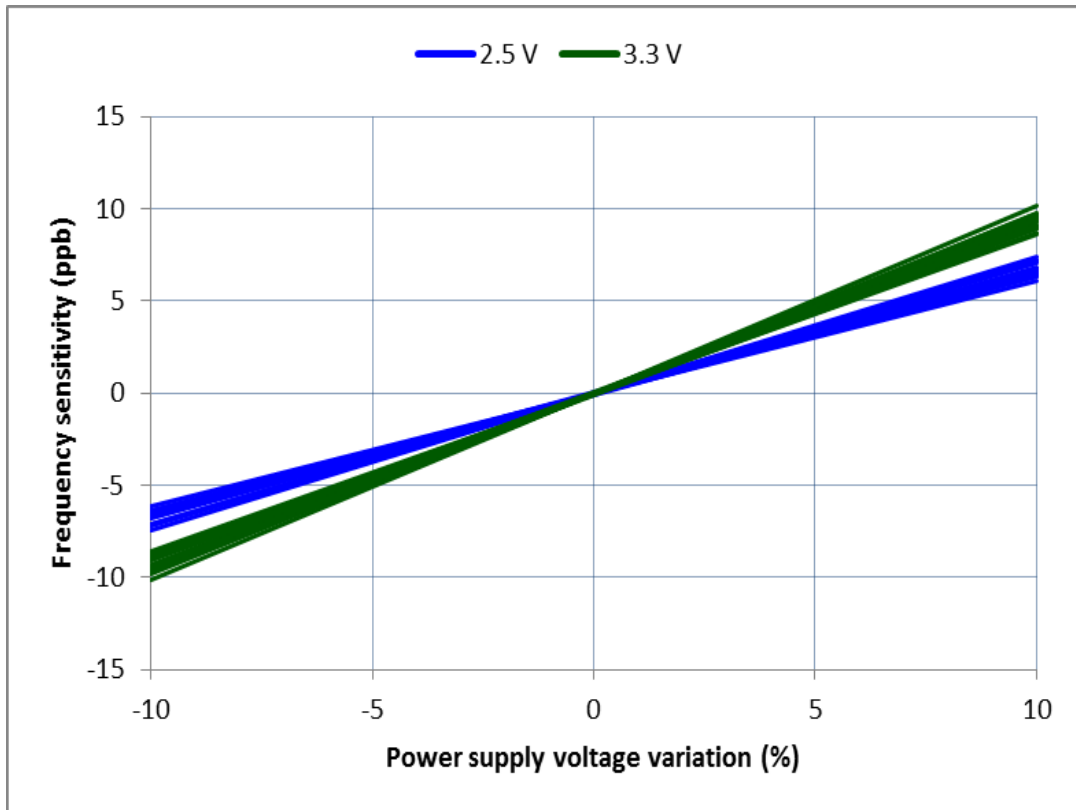

Figure 13: Output frequency power supply sensitivity, 30 devices

The information contained in this document is confidential and proprietary to SiTime Corporation. Unauthorized reproduction or distribution is prohibited.



Title:	Performance report for SiT5156, 10 MHz, Clipped Sinewave		
Type:	Performance report	Rev:	1.2
Orig:		Date:	July 17, 2018

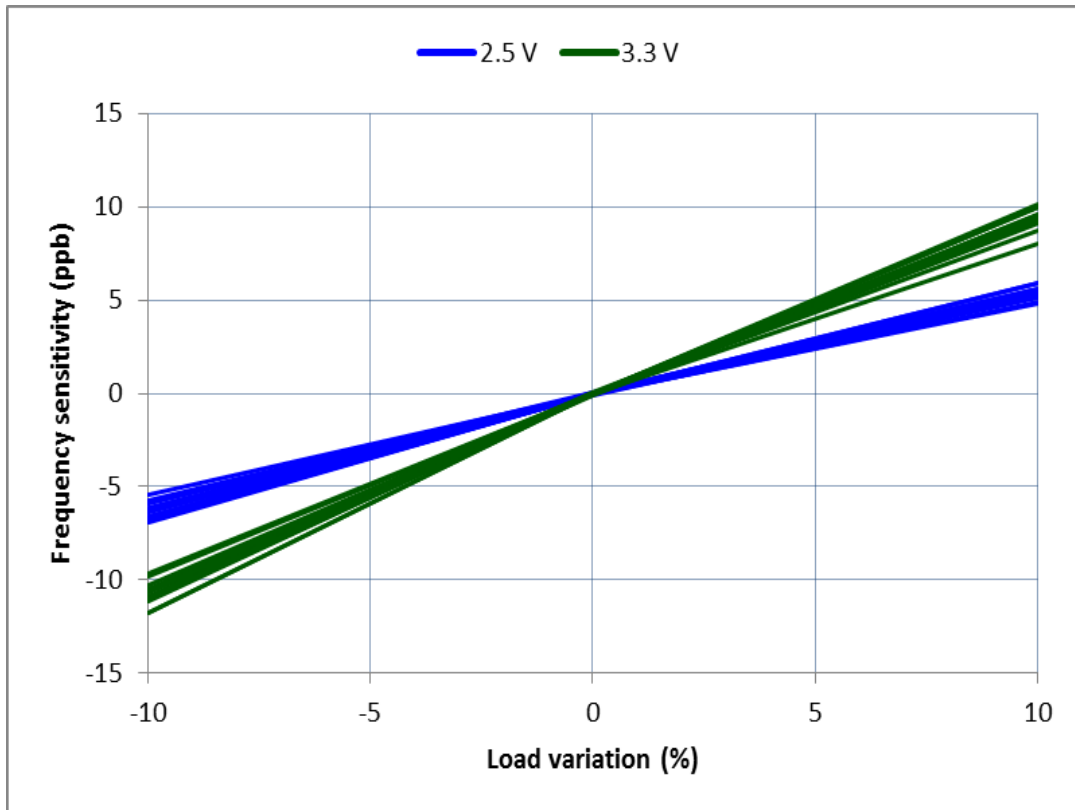

Figure 14: Output frequency load sensitivity, 30 devices

	Title:	Performance report for SiT5156, 10 MHz, Clipped Sinewave		
	Type:	Performance report	Rev:	1.2
	Orig:		Date:	July 17, 2018



Figure 15: Output waveform, 2.5 V

	Title:	Performance report for SiT5156, 10 MHz, Clipped Sinewave		
	Type:	Performance report	Rev:	1.2
	Orig:		Date:	July 17, 2018



Figure 16: Output waveform, 2.8 V

The information contained in this document is confidential and proprietary to SiTime Corporation. Unauthorized reproduction or distribution is prohibited.

	Title:	Performance report for SiT5156, 10 MHz, Clipped Sinewave		
	Type:	Performance report	Rev:	1.2
	Orig:		Date:	July 17, 2018



Figure 17: Output waveform, 3.0 V

The information contained in this document is confidential and proprietary to SiTime Corporation. Unauthorized reproduction or distribution is prohibited.

	Title:	Performance report for SiT5156, 10 MHz, Clipped Sinewave		
	Type:	Performance report	Rev:	1.2
	Orig:		Date:	July 17, 2018



Figure 18: Output waveform, 3.3 V

The information contained in this document is confidential and proprietary to SiTime Corporation. Unauthorized reproduction or distribution is prohibited.

SiTime	Title:	Performance report for SiT5156, 10 MHz, Clipped Sinewave		
	Type:	Performance report	Rev:	1.2
	Orig:		Date:	July 17, 2018

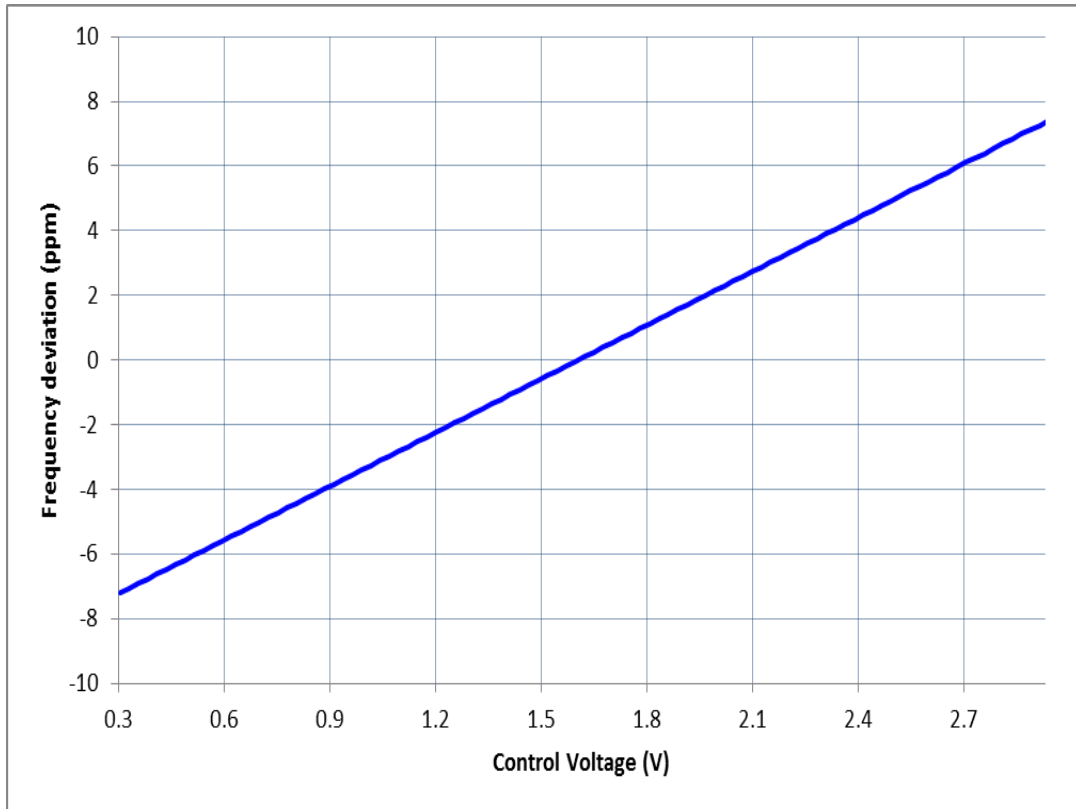

Figure 19: Pull range linearity VCTCXO.

*Referred to the output frequency for control voltage equal to VDD/2

The information contained in this document is confidential and proprietary to SiTime Corporation. Unauthorized reproduction or distribution is prohibited.

SiTime	Title:	Performance report for SiT5156, 10 MHz, Clipped Sinewave		
	Type:	Performance report	Rev:	1.2
	Orig:		Date:	July 17, 2018

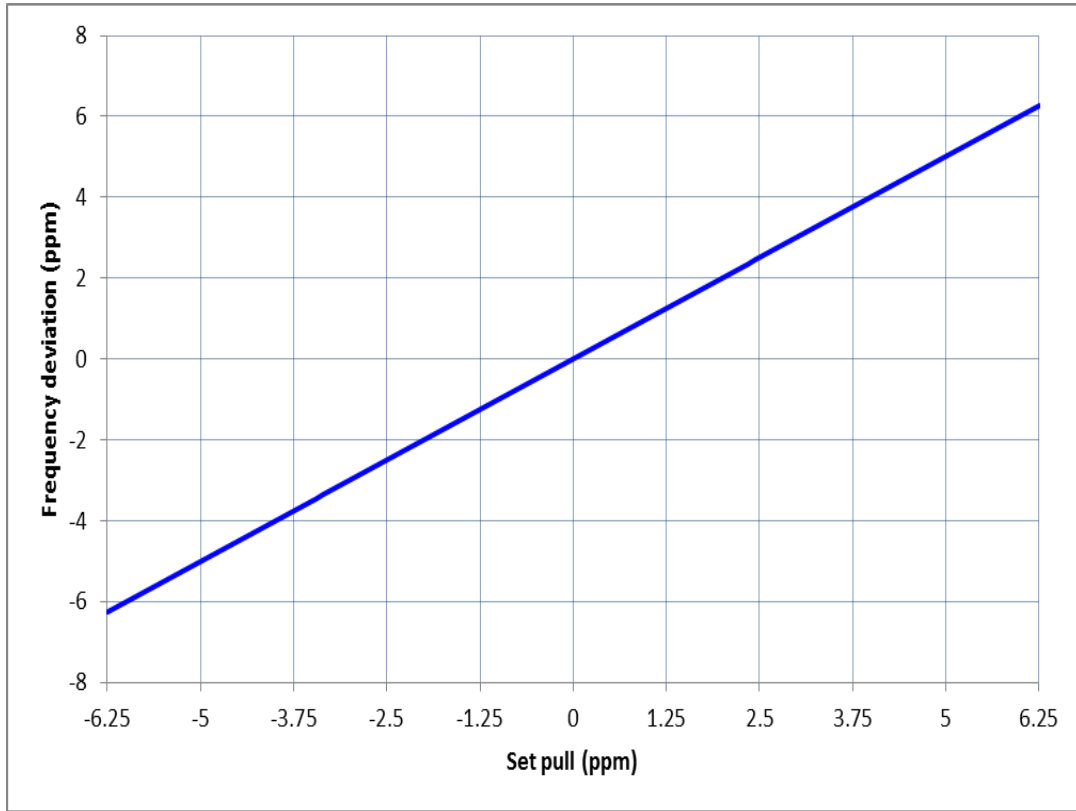

Figure 20: Pull range linearity DCTCXO.

*Referred to the output frequency for frequency control value equal to 0

	Title:	Performance report for SiT5156, 10 MHz, Clipped Sinewave		
	Type:	Performance report	Rev:	1.2
	Orig:		Date:	July 17, 2018

Table 4: Summary performance data

Parameter	Units	Voltage			
		2.5 V	2.8 V	3.0 V	3.3 V
TCXO/DCTCXO Integrated Phase jitter (12 kHz - 5 MHz)	fs, rms	364	372	375	368
VCTCXO Integrated Phase jitter (12 kHz - 5 MHz)	fs, rms	378	374	385	396
Duty cycle	%	49.8	49.9	49.9	49.9
Rise time (20% - 80%)	ps	3.27	3.22	3.20	3.19
Fall time (80% - 20%)	ps	3.63	3.71	3.70	3.65
Amplitude	V	0.96	0.96	0.96	0.96
Current consumption TCXO (no load)	mA	43.7	43.7	43.7	43.8
Current consumption VCTCXO (no load)	mA	47.1	47.3	47.3	47.4
Current consumption DCTCXO (no load)	mA	44.1	44.2	44.2	44.4

Conditions:

- Frequency: 10 MHz
- VDD: 2.5 V, 2.8 V, 3.0 V, 3.3 V
- Pull range: ± 6.25 ppm
- Temperature: 25 °C

Equipment:

Model	Measurement / Purpose
Keysight DSA90604A (6 GHz, 20 Gsps)	Output amplitude, rise/fall time, duty cycle
Keysight 5052B Signal Source Analyzer	Phase noise, integrated phase jitter
Keysight 34980A	Power supply current
Keysight E3631A	Power supply
Keysight 53230A	Frequency

Test setup:

For waveform parameters measurement (rise/fall time, amplitude, duty cycle), DUT output is loaded with 10 pF || 10 k Ω . Output signal is measured using Keysight 1134B active probe with Keysight N5425B probe head. Figure 21 shows test setup diagram for waveform parameters measurement.

SiTime	Title:	Performance report for SiT5156, 10 MHz, Clipped Sinewave		
	Type:	Performance report	Rev:	1.2
	Orig:		Date:	July 17, 2018

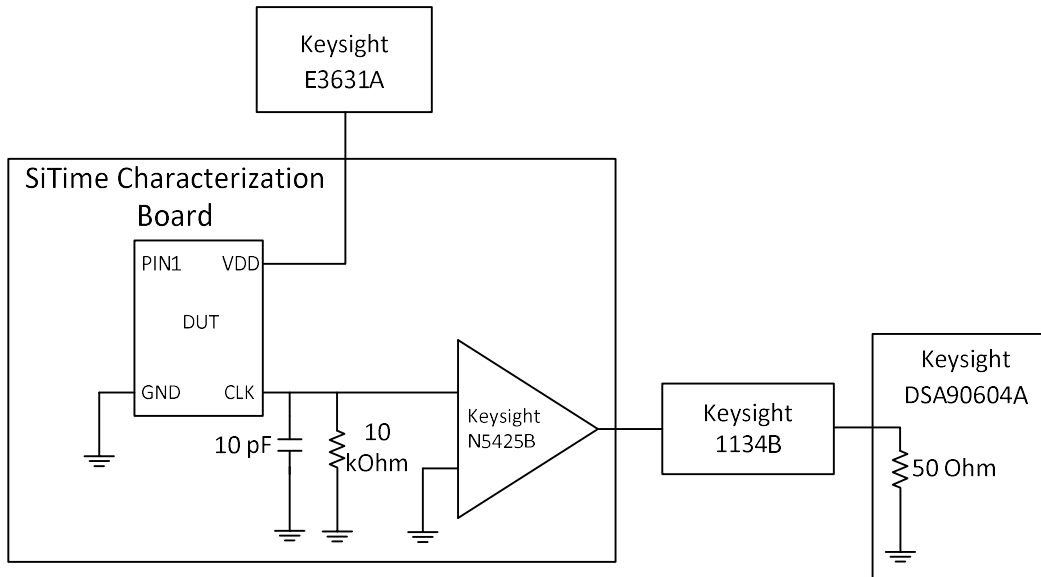

Figure 21: Test setup for measuring waveform parameters (rise/fall time, amplitude, duty cycle)

For phase noise measurements output is connected to 50 Ω measurement instrument input through Mini Circuits RF amplifier (ZX60-3018G-S+). Amplifier output is AC coupled. Figure 22 shows test setup diagram for phase noise measurement.

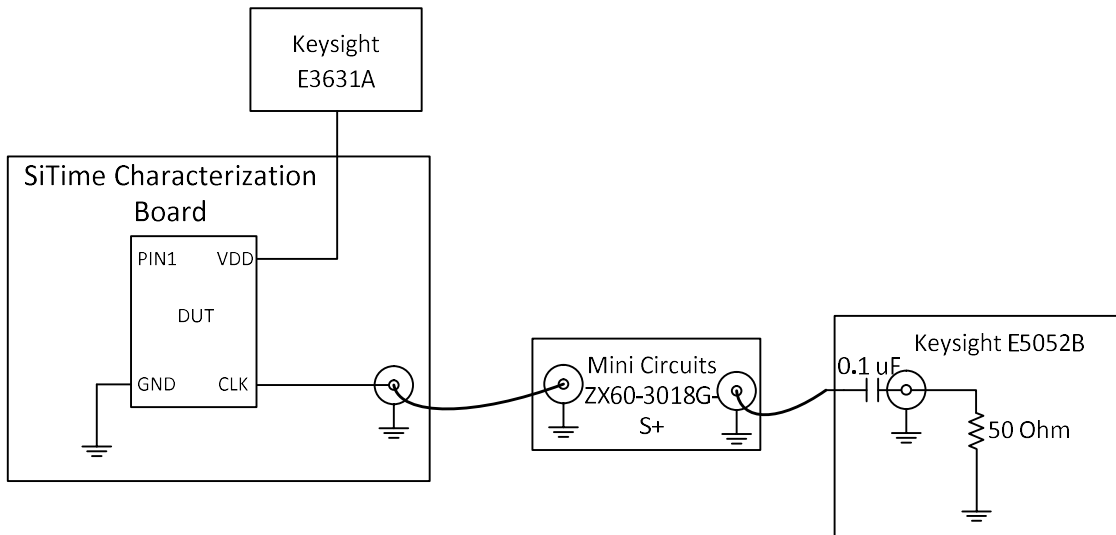

Figure 22: Test setup for measuring phase noise

SiTime	Title:	Performance report for SiT5156, 10 MHz, Clipped Sinewave		
	Type:	Performance report	Rev:	1.2
	Orig:		Date:	July 17, 2018

For frequency measurement (stability over temperature, frequency hysteresis, stability over voltage, stability over load, ADEV, TDEV, MTIE) buffered device output is connected to 50 Ω measurement instrument input (see figure 23).

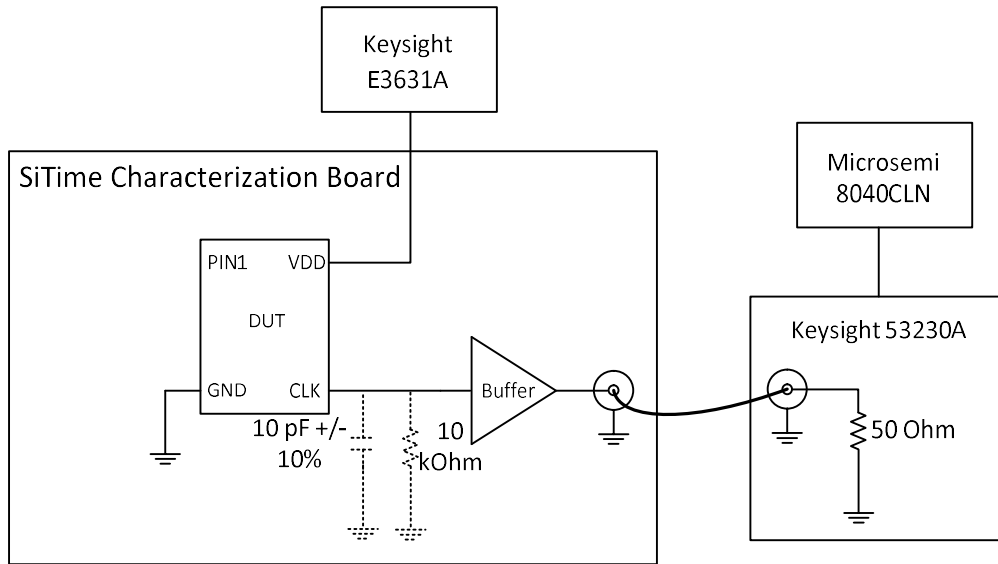

Figure 23: Test setup for measuring frequency

For wander (MTIE, TDEV) measurement AD9548 DPLL is used. DPLL is referenced from rubidium frequency reference. SiTime Super-TCXO is used as system clock for DPLL programmed to different bandwidths. Frequency is measured continuously (gap free mode) with 33 ms gate time. Figure 24 shows setup diagram for wander measurements.

SiTime	Title:	Performance report for SiT5156, 10 MHz, Clipped Sinewave		
	Type:	Performance report	Rev:	1.2
	Orig:		Date:	July 17, 2018

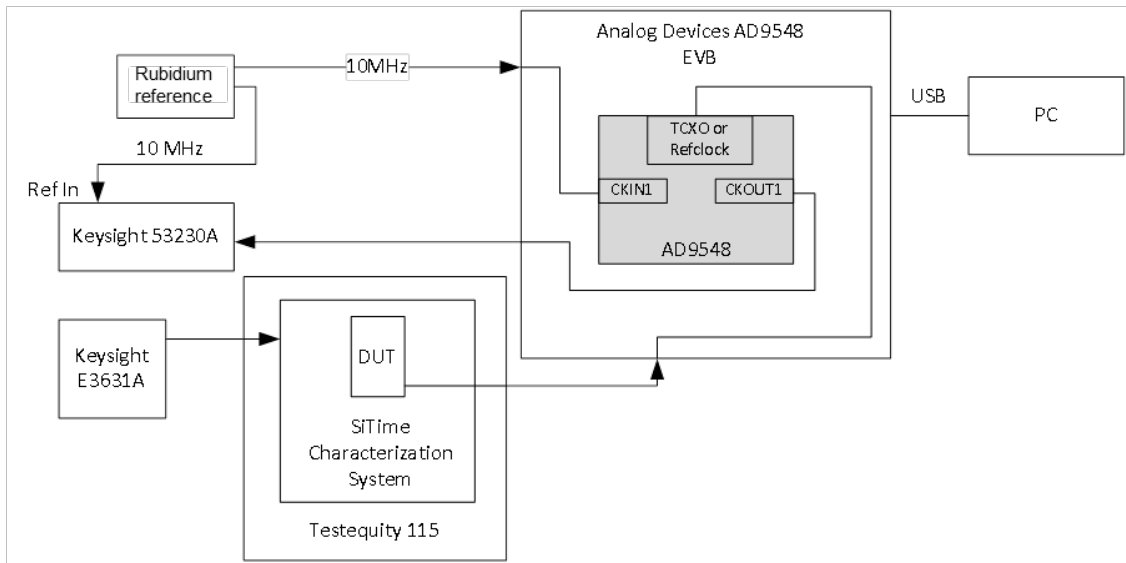

Figure 24: Test setup for measuring wander

The information contained in this document is confidential and proprietary to SiTime Corporation. Unauthorized reproduction or distribution is prohibited.