	Title:	Performance report for SiT9365, 75 MHz, LVPECL		
	Type:	Performance report	Rev:	1.0
	Orig:		Date:	April 16, 2018

Performance report for SiT9365 - 75 MHz, LVPECL

Conditions:

- Frequency 75 MHz
- VDD: 2.5 V, 3.3 V
- Room temperature
- Termination:
 - o 50 Ω to VDD – 2 V.

Equipment:

Model	Measurement / Purpose
Keysight DSA90604A (6 GHz, 20 Gbps)	Period jitter, differential voltage swing, rise/fall time, duty cycle
Keysight 5052B Signal Source Analyzer	Phase noise, integrated phase jitter
Keysight 34980A	Power supply current
Keysight E3631A	Power supply
Keysight 53230A	Frequency

Test setup:

For waveform parameters measurement (rise/fall time, differential swing, duty cycle), both DUT outputs are terminated with 50 Ω to VDD - 2 V. Output signals are measured using Keysight 1134B active probe with Keysight N5425B probe head. All measurements are applied to the differential waveform. Figure 1 shows test setup diagram for waveform parameters measurement.

	Title:	Performance report for SiT9365, 75 MHz, LVPECL		
	Type:	Performance report	Rev:	1.0
	Orig:		Date:	April 16, 2018

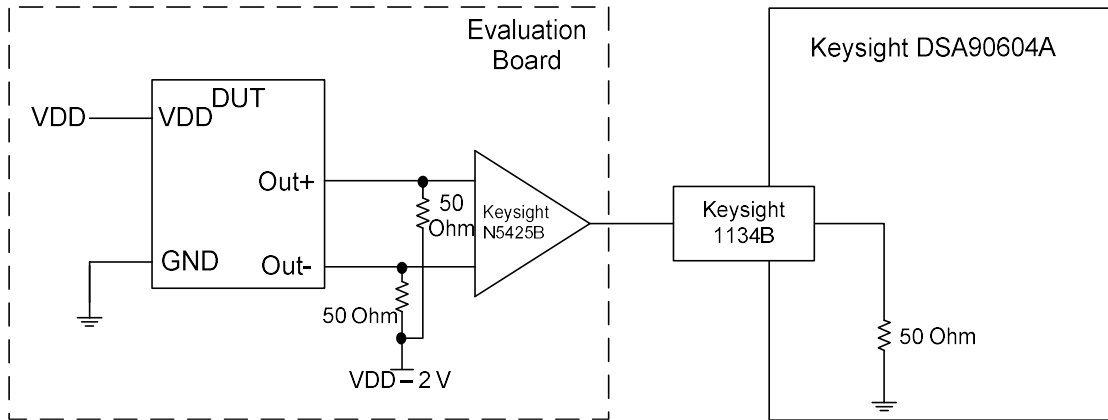

Figure 1: Test setup for measuring waveform parameters (rise/fall time, differential swing, duty cycle)

For period jitter measurement output is terminated with $50\ \Omega$ to $VDD - 2\ V$ at the input of hi-speed comparator (ADCMP581). AC coupled comparator's output is connected to oscilloscope channel. Figure 2 shows test setup diagram for period jitter measurement.



Figure 2: Test setup for measuring period jitter

For phase noise measurements, differential signal is converted to single-ended using impedance matching transformer. Transformer's output is connected to measurement instrument. Output is also terminated with $30\ \Omega$ series at the source side. Figure 3 shows test setup diagram for phase noise measurement.

SiTime	Title:	Performance report for SiT9365, 75 MHz, LVPECL		
	Type:	Performance report	Rev:	1.0
	Orig:		Date:	April 16, 2018



Figure 3: Test setup for measuring phase noise.

For IDD measurement device output is floating. For frequency measurement differential-to-single-ended converter is used.

Data:

- Phase noise
- Integrated phase jitter
- RMS period jitter
- Peak-to-peak period jitter
- Rise/fall time
- Duty cycle
- Differential output swing
- IDD
- Frequency stability over temperature

Table 1: Summary performance data

Parameter	Units	Voltage	
		2.5 V	3.3 V
Integrated Phase jitter (1.875 MHz - 20 MHz)	fs, rms	157	166
Integrated Phase jitter (12 kHz - 20 MHz)	fs, rms	247	254
Period jitter	ps, rms	1.07	1.07
Period jitter (10,000 cycles)	ps, pk-pk	8.43	8.37
Duty cycle	%	50.0	50.0
Rise time (20% - 80%)	ps	252	240
Fall time (80% - 20%)	ps	250	238
Differential voltage swing	V	1.60	1.58
Current consumption (no load, output enabled)	mA	75.4	75.7
Current consumption (no load, output disabled)	mA	49.8	49.9

SiTime	Title:	Performance report for SiT9365, 75 MHz, LVPECL		
	Type:	Performance report	Rev:	1.0
	Orig:		Date:	April 16, 2018

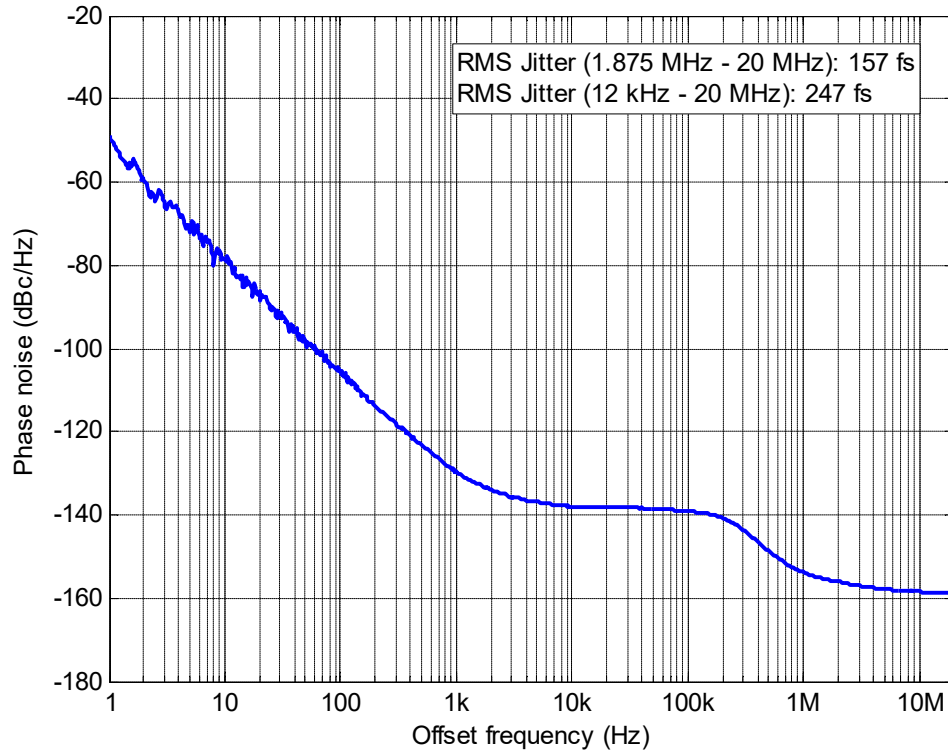

Figure 4: Phase noise, 2.5 V

The information contained in this document is confidential and proprietary to SiTime Corporation. Unauthorized reproduction or distribution is prohibited.

SiTime	Title:	Performance report for SiT9365, 75 MHz, LVPECL		
	Type:	Performance report	Rev:	1.0
	Orig:		Date:	April 16, 2018

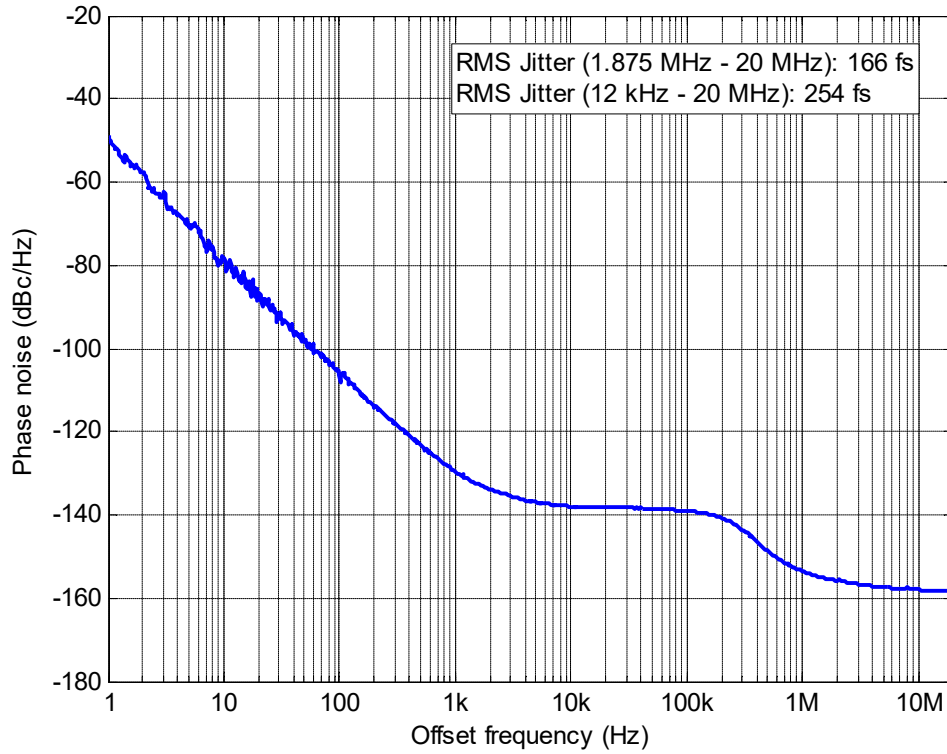

Figure 5: Phase noise, 3.3 V

The information contained in this document is confidential and proprietary to SiTime Corporation. Unauthorized reproduction or distribution is prohibited.

	Title:	Performance report for SiT9365, 75 MHz, LVPECL		
	Type:	Performance report	Rev:	1.0
	Orig:		Date:	April 16, 2018



Figure 6: Output waveform, 2.5 V

The information contained in this document is confidential and proprietary to SiTime Corporation. Unauthorized reproduction or distribution is prohibited.

	Title:	Performance report for SiT9365, 75 MHz, LVPECL		
	Type:	Performance report	Rev:	1.0
	Orig:		Date:	April 16, 2018



Figure 7: Output waveform, 3.3 V

The information contained in this document is confidential and proprietary to SiTime Corporation. Unauthorized reproduction or distribution is prohibited.

SiTime	Title:	Performance report for SiT9365, 75 MHz, LVPECL		
	Type:	Performance report	Rev:	1.0
	Orig:		Date:	April 16, 2018

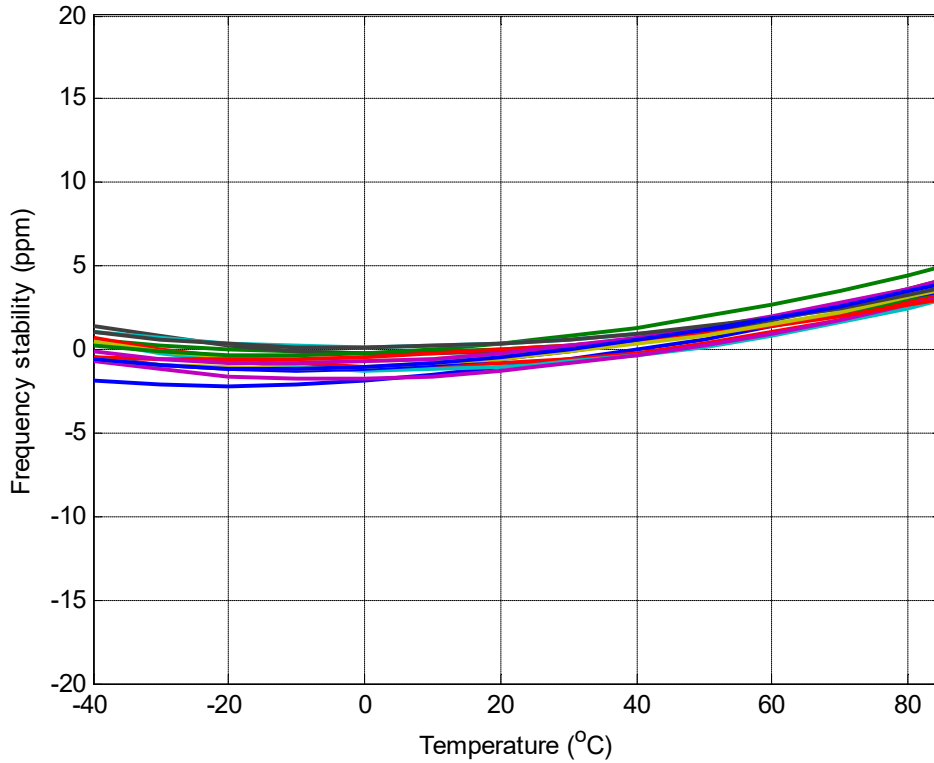

Figure 8: Frequency stability* over temperature, 2.5 V

*SiT9365 frequency stability is independent of output frequency.

The information contained in this document is confidential and proprietary to SiTime Corporation. Unauthorized reproduction or distribution is prohibited.

SiTime	Title:	Performance report for SiT9365, 75 MHz, LVPECL		
	Type:	Performance report	Rev:	1.0
	Orig:		Date:	April 16, 2018

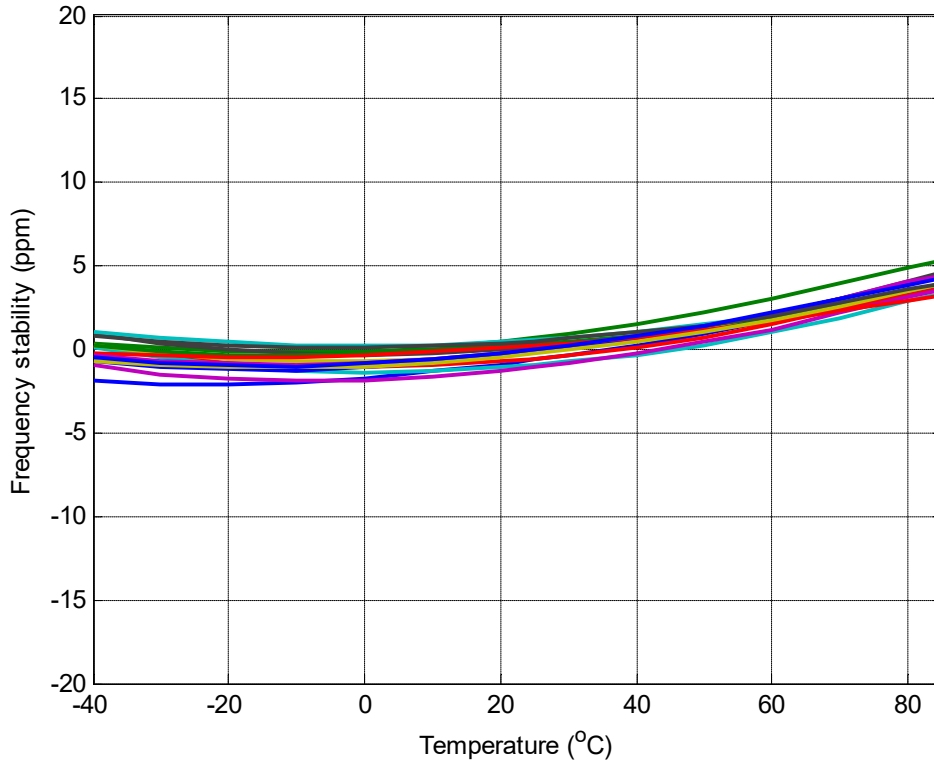

Figure 9: Frequency stability over temperature, 3.3 V

The information contained in this document is confidential and proprietary to SiTime Corporation. Unauthorized reproduction or distribution is prohibited.