

| | | | | |
|---|---------------|---|--------------|----------------|
|  | Title: | Performance report for SiT9366, 30.72 MHz, LVPECL | | |
| | Type: | Performance report | Rev: | 1.0 |
| | Orig: | | Date: | April 16, 2018 |

Performance report for SiT9366 - 30.72 MHz, LVPECL

Conditions:

- Frequency 30.72 MHz
- VDD: 2.5 V, 3.3 V
- Room temperature
- Termination:
 - o 50 Ω to VDD – 2 V.

Equipment:

| Model | Measurement / Purpose |
|---------------------------------------|---|
| Keysight DSA90604A (6 GHz, 20 Gps) | Period jitter, differential voltage swing, rise/fall time, duty cycle |
| Keysight 5052B Signal Source Analyzer | Phase noise, integrated phase jitter |
| Keysight 34980A | Power supply current |
| Keysight E3631A | Power supply |
| Keysight 53230A | Frequency |

Test setup:

For waveform parameters measurement (rise/fall time, differential swing, duty cycle), both DUT outputs are terminated with 50 Ω to VDD - 2 V. Output signals are measured using Keysight 1134B active probe with Keysight N5425B probe head. All measurements are applied to the differential waveform. Figure 1 shows test setup diagram for waveform parameters measurement.

| | | | | |
|---|---------------|---|--------------|----------------|
|  | Title: | Performance report for SiT9366, 30.72 MHz, LVPECL | | |
| | Type: | Performance report | Rev: | 1.0 |
| | Orig: | | Date: | April 16, 2018 |

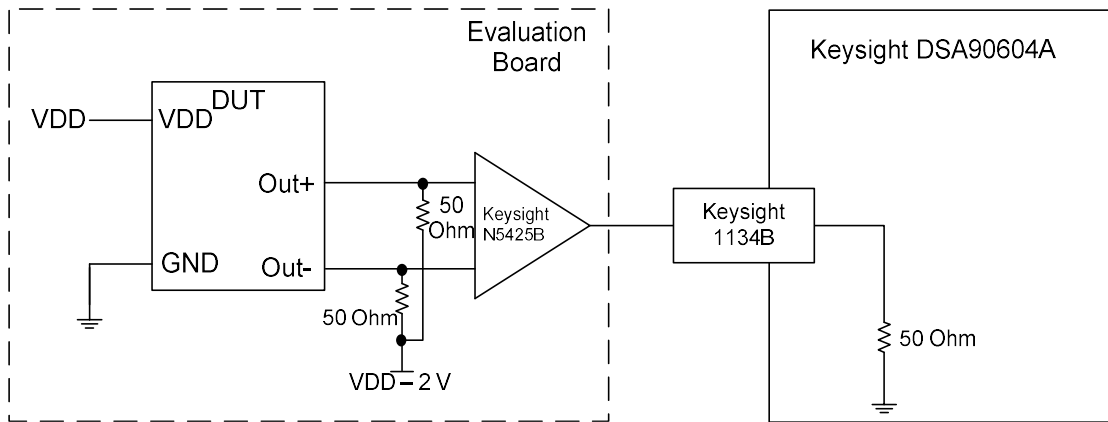

Figure 1: Test setup for measuring waveform parameters (rise/fall time, differential swing, duty cycle)

For period jitter measurement output is terminated with $50\ \Omega$ to $VDD - 2\ V$ at the input of hi-speed comparator (ADCMP581). AC coupled comparator's output is connected to oscilloscope channel. Figure 2 shows test setup diagram for period jitter measurement.



Figure 2: Test setup for measuring period jitter

For phase noise measurements, differential signal is converted to single-ended using impedance matching transformer. Transformer's output is connected to measurement instrument. Output is also terminated with $30\ \Omega$ series at the source side. Figure 3 shows test setup diagram for phase noise measurement.

| | | | | |
|---------------|---------------|--|--------------|-----------------------|
| SiTime | Title: | Performance report for SiT9366, 30.72 MHz, LVPECL | | |
| | Type: | Performance report | Rev: | 1.0 |
| | Orig: | | Date: | April 16, 2018 |



Figure 3: Test setup for measuring phase noise.

For IDD measurement device output is floating. For frequency measurement differential-to-single-ended converter is used.

Data:

- Phase noise
- Integrated phase jitter
- RMS period jitter
- Peak-to-peak period jitter
- Rise/fall time
- Duty cycle
- Differential output swing
- IDD
- Frequency stability over temperature

Table 1: Summary performance data

| Parameter | Units | Voltage | |
|--|-----------|---------|-------|
| | | 2.5 V | 3.3 V |
| Integrated Phase jitter (1.875 MHz - 5 MHz) | fs, rms | 81 | 81 |
| Integrated Phase jitter (12 kHz - 5 MHz) | fs, rms | 198 | 192 |
| Period jitter | ps, rms | 1.07 | 1.06 |
| Period jitter (10,000 cycles) | ps, pk-pk | 8.37 | 8.24 |
| Duty cycle | % | 50.0 | 50.0 |
| Rise time (20% - 80%) | ps | 251 | 242 |
| Fall time (80% - 20%) | ps | 248 | 240 |
| Differential voltage swing | V | 1.59 | 1.58 |
| Current consumption (no load, output enabled) | mA | 75.5 | 75.7 |
| Current consumption (no load, output disabled) | mA | 50.0 | 50.0 |

The information contained in this document is confidential and proprietary to SiTime Corporation. Unauthorized reproduction or distribution is prohibited.

| | | | | |
|---------------|---------------|---|--------------|----------------|
| SiTime | Title: | Performance report for SiT9366, 30.72 MHz, LVPECL | | |
| | Type: | Performance report | Rev: | 1.0 |
| | Orig: | | Date: | April 16, 2018 |

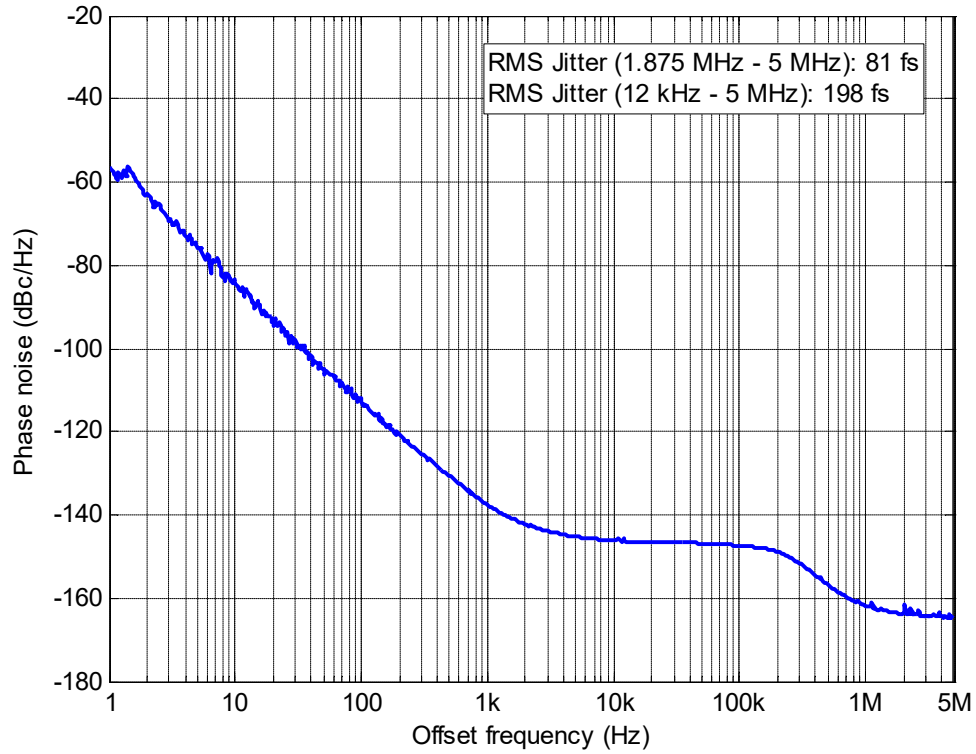

Figure 4: Phase noise, 2.5 V

The information contained in this document is confidential and proprietary to SiTime Corporation. Unauthorized reproduction or distribution is prohibited.

| | | | | |
|---------------|---------------|---|--------------|----------------|
| SiTime | Title: | Performance report for SiT9366, 30.72 MHz, LVPECL | | |
| | Type: | Performance report | Rev: | 1.0 |
| | Orig: | | Date: | April 16, 2018 |

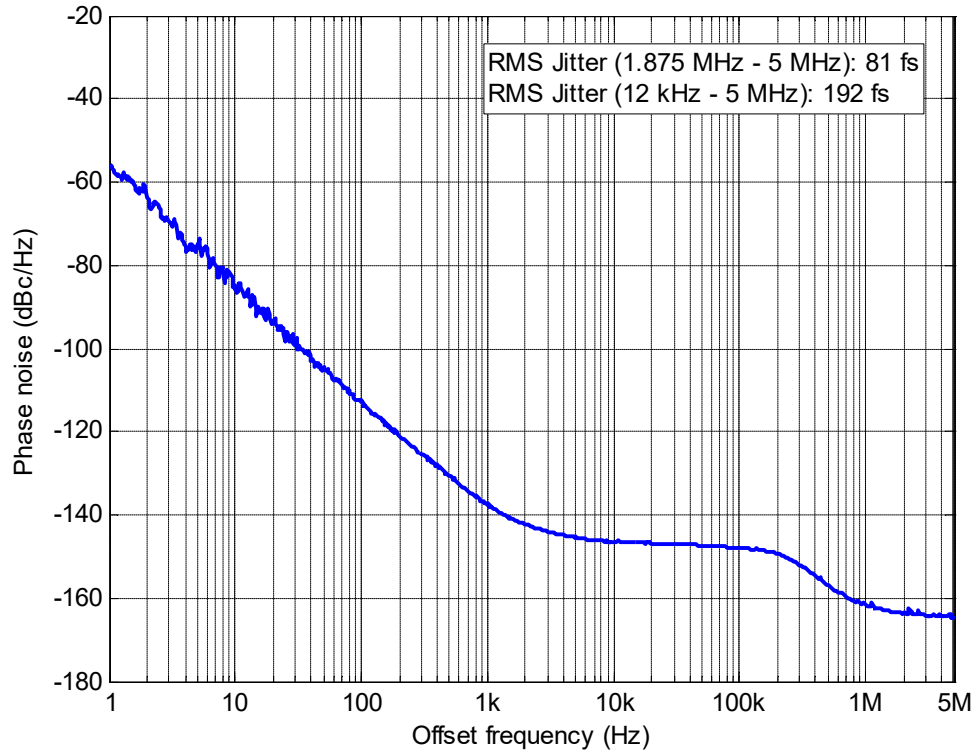

Figure 5: Phase noise, 3.3 V

The information contained in this document is confidential and proprietary to SiTime Corporation. Unauthorized reproduction or distribution is prohibited.

| | | | | |
|---|---------------|---|--------------|----------------|
|  | Title: | Performance report for SiT9366, 30.72 MHz, LVPECL | | |
| | Type: | Performance report | Rev: | 1.0 |
| | Orig: | | Date: | April 16, 2018 |



Figure 6: Output waveform, 2.5 V

The information contained in this document is confidential and proprietary to SiTime Corporation. Unauthorized reproduction or distribution is prohibited.

| | | | | |
|---------------|---------------|---|--------------|----------------|
| SiTime | Title: | Performance report for SiT9366, 30.72 MHz, LVPECL | | |
| | Type: | Performance report | Rev: | 1.0 |
| | Orig: | | Date: | April 16, 2018 |



Figure 7: Output waveform, 3.3 V

The information contained in this document is confidential and proprietary to SiTime Corporation. Unauthorized reproduction or distribution is prohibited.

| | | | | |
|---------------|---------------|---|--------------|----------------|
| SiTime | Title: | Performance report for SiT9366, 30.72 MHz, LVPECL | | |
| | Type: | Performance report | Rev: | 1.0 |
| | Orig: | | Date: | April 16, 2018 |

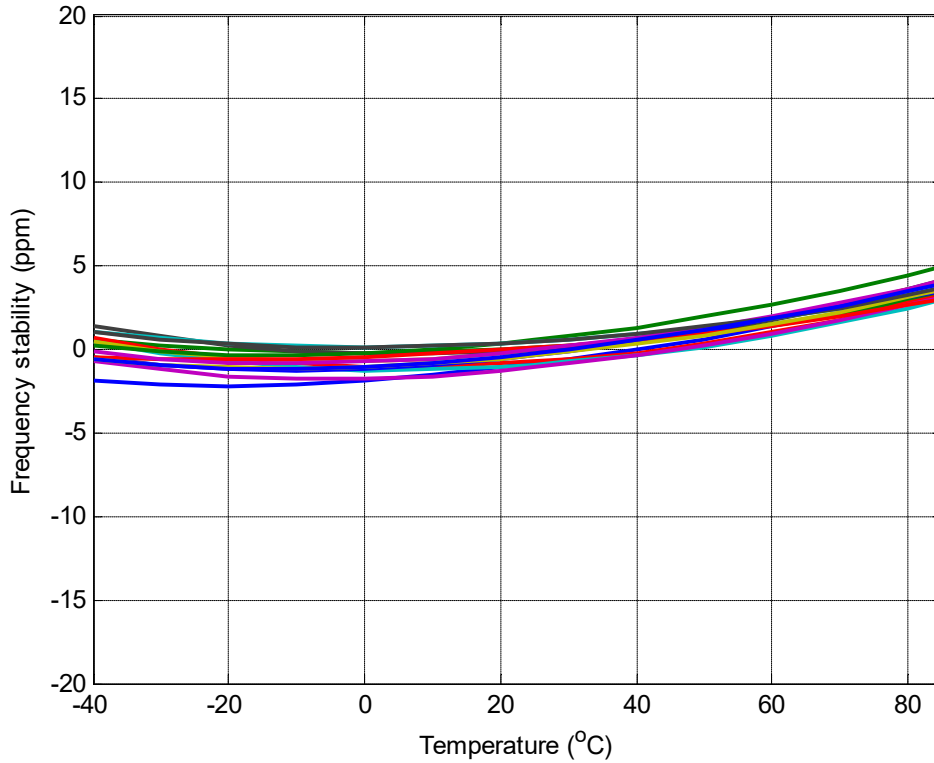

Figure 8: Frequency stability* over temperature, 2.5 V

*SiT9366 frequency stability is independent of output frequency.

The information contained in this document is confidential and proprietary to SiTime Corporation. Unauthorized reproduction or distribution is prohibited.

| | | | | |
|---------------|---------------|---|--------------|----------------|
| SiTime | Title: | Performance report for SiT9366, 30.72 MHz, LVPECL | | |
| | Type: | Performance report | Rev: | 1.0 |
| | Orig: | | Date: | April 16, 2018 |

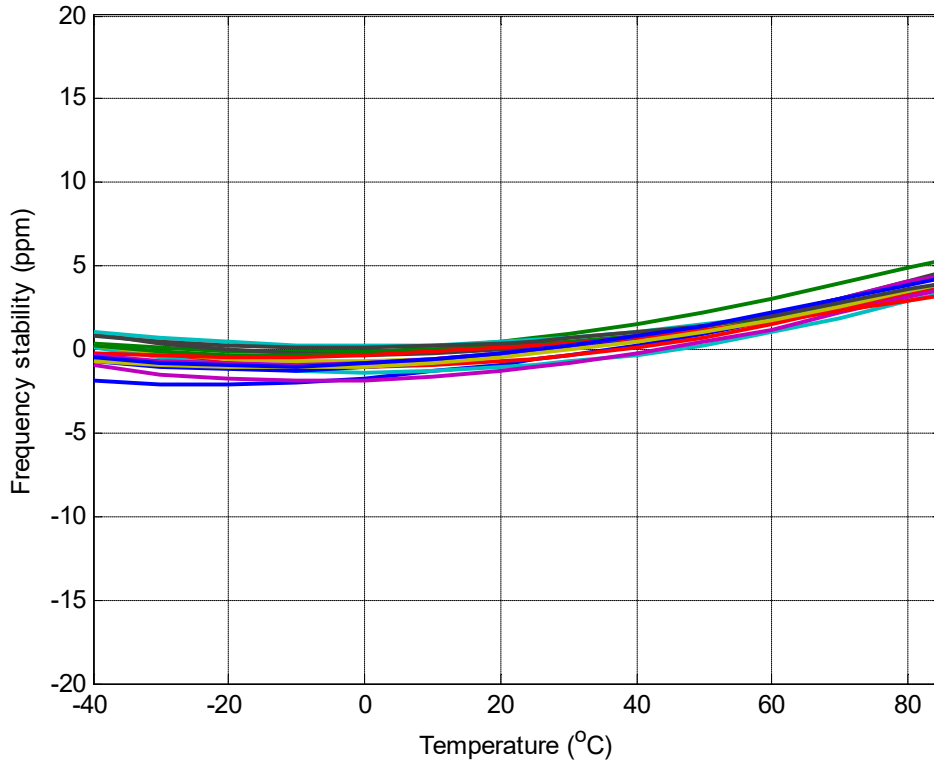

Figure 9: Frequency stability over temperature, 3.3 V

The information contained in this document is confidential and proprietary to SiTime Corporation. Unauthorized reproduction or distribution is prohibited.